

FLOOD LIGHT

Product Images

APPLICATION AREAS:

Sports facilities, Studio,
Stage, Supermarkets, Industrial buildings



TECHNICAL SPECIFICATIONS

PRODUCT REFERENCE

ITEM CODE	FLOOD LIGHT 50
ENVIRONMENT	OUTDOOR WALL MOUNTED
INSTALLATION	MOUNTED

CONSTRUCTION AND MATERIALS

SIZE OUT SIDE MM	252x252x65
CUT OUT SIZE (MM)	-
HOUSING	Die Cast Aluminium
LENS / DIFFUSER	Tempered Glass
REFLECTOR	N/A
SURFACE FINISH	GREY POWDER COATED

THERMAL MANAGEMENT

HEAT SINK MATERIAL	Aluminium
COOLING TECHNIQUE	Passive

OPTICAL SYSTEM

BEAM ANGLE	110°
ILLUMINATION MODE	Indirect Lighting
SWIVEL	No

LIGHT TECHNOLOGY

LED FITTED	Bridgelux
DELIVERED LUMENS	6300 / 6000 / 5700
CCT (K)	6000 / 4000 / 3000
Tunable	On Request
LED BINNING	3 Step MacAdam
CRI (Ra)	80 / 90
LED LIFE L70	45,000 HRS
LUMINAIRE	7000 / 6750 / 6500
LUMINOUS FLUX	
LUMINOUS EFFICACY	130 Lumens / Watt

ELECTRICAL SYSTEM

(UGR)	<18
INPUT VOLTAGE	220 TO 240 Vac
INPUT POWER	50W
POWER FACTOR	>0.95
THD	<10%
CONTROL GEAR	IN BUILT
MOUNTING	
DRIVER PROTECTION	OVP, Short Circuit, Surge
DIMMING	OPTION/AL
EMERGENCY	On Request
BATTERY BACKUP	

PACKAGING DETAILS

PACKING QTY -

GROSS WEIGHT -

**CARTOON SIZE -
(LXBXH)**

DIMENSIONS

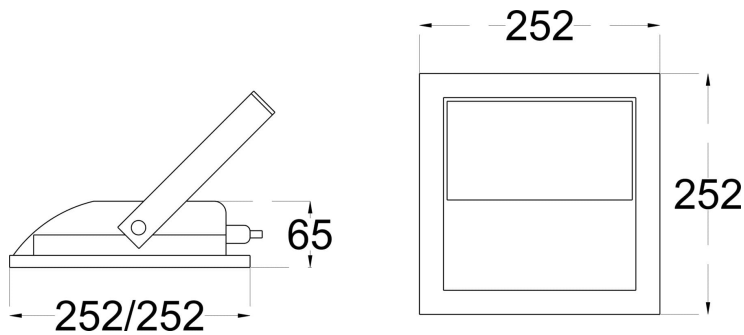

PHOTOMETRIC

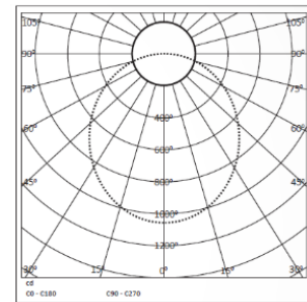

ARCADE LIGHTING INDUSTRIES PVT LTD

8 Raju industrial estate, Penkar pada, Near
dahisar check naka, Mira road 401107

NOTE : The technical data sheet with design registration stamp is the property of Arcade Lighting India Pvt. Ltd. & protected under Intellectual Property law, and it is restricted for sharing with other lighting suppliers

Technical parameters are subjected to change time to time in order to improve product performance and reliability
BP-RV00 AR/FRT/TEC/TDS/01