

MAXLUX[®]

Towards Greener Tomorrow

SPECIFICATION SHEET : MX405083

ELECTRICAL DATA

RATED MAINS VOLTAGE	240 Vac
OPERATING INPUT VOLTAGE RANGE	110Vac~277Vac, 50/60Hz
OPTIMUM PERFORMANCE INPUT VOLTAGE RANGE	150Vac~260Vac, 50/60Hz
INPUT CURRENT (MAX)	0.18A
POWER FACTOR	> 0.98
Athd	< 10%
EFFICIENCY	>88%
OPERATING TYPE	Constant Current
OUTPUT CURRENT	830mA ± 3%
OUTPUT VOLTAGE	40~50 Vdc
OUTPUT WATTAGE	38W (Max)
NUMBER OF OUTPUT CHANNELS	1
EMI	N.A.
DIMMING CONTROLLER TYPE	N.A.
DIMMING RANGE	N.A.
MAX CASE HOT SPOT TEMPERATURE	75°C
OPERATING TEMPERATURE	-10°C to 50°C
APPROVALS CLASS(CONFORMING TO)	SELV Equivalent
CASE MATERIAL	Plastic (PC)

CIRCUIT PROTECTION

SURGE PROTECTION	Line-Neutral 2.5kV
INPUT OVER CURRENT PROTECTION	NON-RESETTABLE
INPUT OVER VOLTAGE : APPLICATION	@ 320VAC 48Hrs.
INPUT UNDER VOLTAGE	N.A.
OUTPUT SHORT CIRCUIT PROTECTION	AUTORECOVERY(HICCUP MODE)
OUTPUT OPEN CIRCUIT PROTECTION	AUTORECOVERY(HICCUP MODE)
OUTPUT TO GROUND SHORT PROTECTION	Yes
Note: All performance specified at Rated voltage and full load. Output d	

MECHANICAL DATA

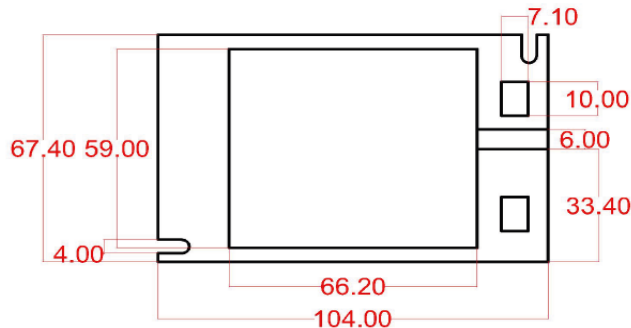

WIRING DIAGRAM

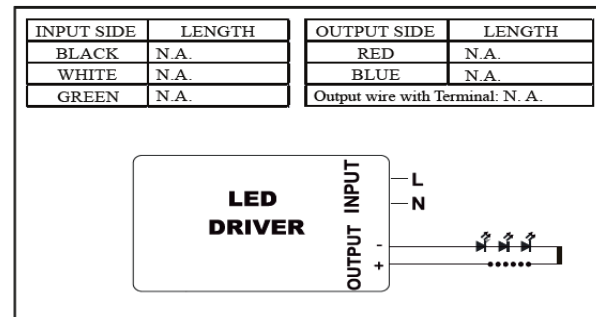

Graph :

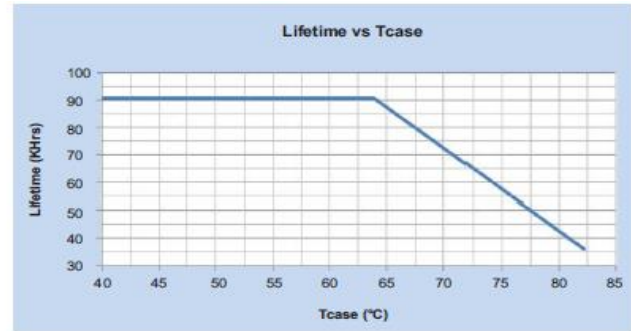
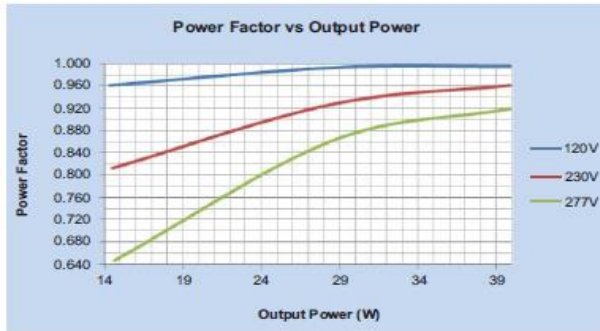
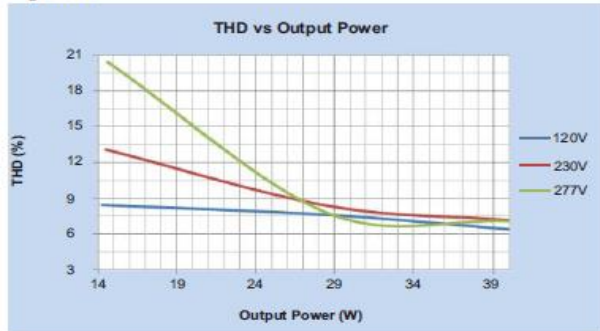

Figure 10



Enclosure :

