



Arcade[®]

**LED SPOT LIGHT &
AUTOMATION
CATALOGUE**

06/2026



LED
Lighting
Solutions

ABOUT ARCADE

Arcade Lighting is a speciality lighting enterprise combining expertise in LED Lighting Solutions. Over 20 years, we have made our presence felt in the industry with our quality range in Industrial, Commercial, Street Lights and Flood Lights under our brand name

The Brand has always been underpinned by knowledge of lighting and profound understanding of its effect on people.

Light is our passion. We have been defining the present and future state of light every day for over 30 years, and with intelligent solutions that not only convince but inspire.

Lighting is simple: we listen carefully and we know the market.

Services And Manufacturing Provided In House

- Fabrication
- Pretreatment Plant
- Powder Coating Driver
- Manufacturing LED pick
& place Reflow
- Machine for LED

- Designing
- Quality Check Product
- Customization Service
- within 72 hours Lux
- Report
- Site Support

Certification

CE By Technická inšpekcia

CE marking is a certification mark that indicates conformity with health, safety, and environmental protection standards for products sold within the European economic area. The CE marking is also found on products sold outside the EEA that are manufactured in, or designed to be sold in, the EEA.



ISO by UKAS & NABCB

The International Organization for Standardization (ISO) is an international standard-setting body composed of representatives from various national standards organizations. Founded on 23 February 1947, the organization promotes worldwide proprietary, industrial and commercial standards.

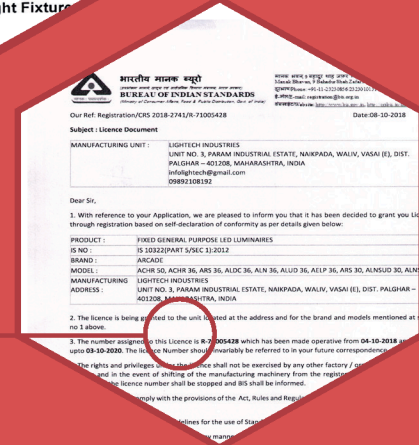

BIS

The Bureau of Indian Standards is the national standards body of India working under the Aegis of Ministry of Consumer Affairs, Food & Public Distribution, Government of India. It is established by the Bureau of Indian Standards Act, 1986 which came into effect on 23rd December 1986.

HOME AUTOMATION



▲
FEATURES

.....

LED SPOT LIGHTS

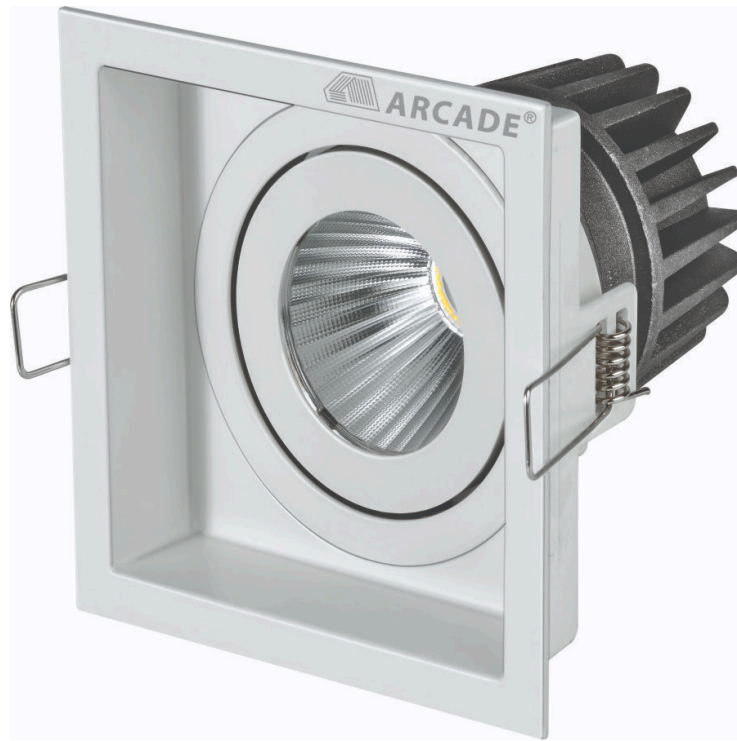

Application: Residential, Office buildings, Retail, Sports facilities, Studio, Stage, Supermarkets, Library

Code	Watt	Lumen CW/NW/WW	Efficacy	A x B	C x D x E
VEGA SQ 6	6W	960 / 930 / 900	115 Lumens / Watt	90x90	75x75x100
VEGA SQ 12	12W	1920 / 1860 / 1800	115 Lumens / Watt	90x90	75x75x100
VEGA SQ 15	15W	2400 / 2325 / 2250	115 Lumens / Watt	110x110	90x90x115
VEGA SQ 20	20W	3200 / 3100 / 3000	115 Lumens / Watt	110x110	90x90x115

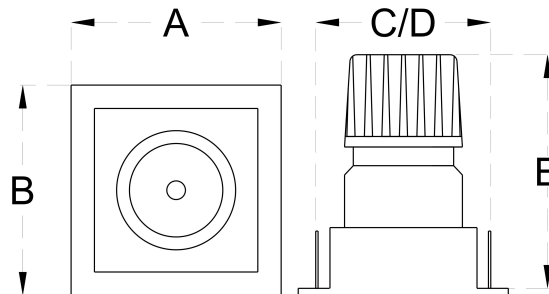



Application: Residential, Office buildings, Retail, Sports facilities, Studio, Stage, Supermarkets, Library

Code	Watt	Lumen CW/NW/WW	Efficacy	A x B	C x D x E
VEGA PLUS SQ 12	12W (2x6W)	1920 / 1860 / 1800	115 Lumens / Watt	170x90	155x75x100
VEGA PLUS SQ 24	24W (2x12W)	3840 / 3720 / 3600	115 Lumens / Watt	170x90	155x75x100
VEGA PLUS SQ 30	30W (2x15W)	4800 / 4650 / 4500	115 Lumens / Watt	210x110	190x90x115
VEGA PLUS SQ 40	40W (2x20W)	6400 / 6200 / 6000	115 Lumens / Watt	210x110	190x90x115

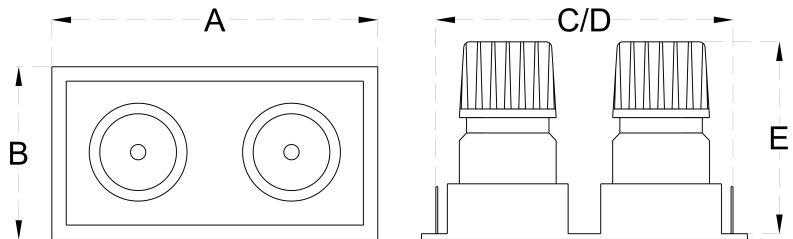



Application: Residential, Office buildings, Retail, Sports facilities, Studio, Stage, Supermarkets, Library

Code	Watt	Lumen CW/NW/WW	Efficacy	A x B	C x D x E
VEGA RD 6	6W	960 / 930 / 900	115 Lumens / Watt	90MM DIA	75x100
VEGA RD 12	12W	1920 / 1860 / 1800	115 Lumens / Watt	90MM DIA	75x100
VEGA RD 15	15W	2400 / 2325 / 2250	115 Lumens / Watt	110 MM DIA	90x115
VEGA RD 20	20W	3200 / 3100 / 3000	115 Lumens / Watt	110 MM DIA	90x115

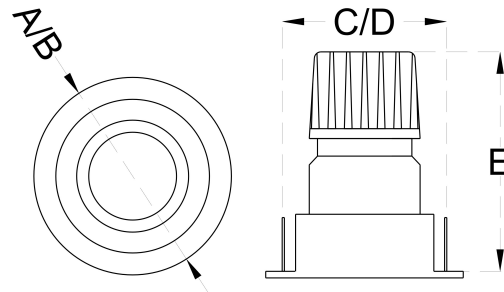



Application: Residential, Office buildings, Retail, Sports facilities, Studio, Stage, Supermarkets, Library

Code	Watt	Lumen CW/NW/WW	Efficacy	A x B	C x D x E
VEGA PLUS RD 12	12W (2x6W)	1920 / 1860 / 1800	115 Lumens / Watt	170x90	155 x75x100
VEGA PLUS RD 24	24W (2x12W)	3840 / 3720 / 3600	115 Lumens / Watt	170x90	155 x75x100
VEGA PLUS RD 30	30W (2x15W)	4800 / 4650 / 4500	115 Lumens / Watt	210x110	190x90x115
VEGA PLUS RD 40	40W (2x20W)	6400 / 6200 / 6000	115 Lumens / Watt	210x110	190x90x115

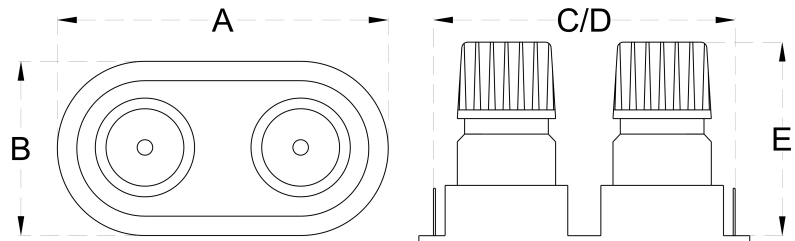



Application: Residential, Office buildings, Retail, Sports facilities, Studio, Stage, Supermarkets, Library

Code	Watt	Lumen CW/NW/WW	Efficacy	A x B	C x D x E
PLATO SQ 6	6W	960 / 930 / 900	115 Lumens / Watt	90x90	75x75x75
PLATO SQ 12	12W	1920 / 1860 / 1800	115 Lumens / Watt	90x90	75x75x75
PLATO SQ 15	15W	2400 / 2325 / 2250	115 Lumens / Watt	110x110	90x90x95
PLATO SQ 20	20W	3200 / 3100 / 3000	115 Lumens / Watt	110x110	90x90x95

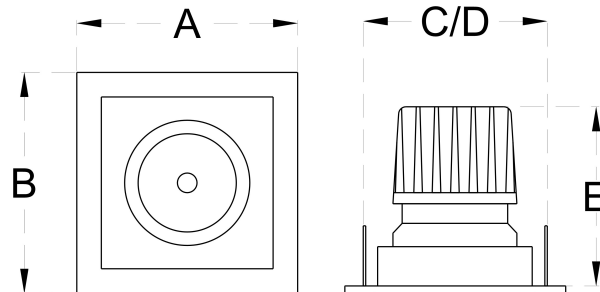



Application: Residential, Office buildings, Retail, Sports facilities, Studio, Stage, Supermarkets, Library

Code	Watt	Lumen CW/NW/WW	Efficacy	A x B	C x D x E
PLATO RD 6	6W	960 / 930 / 900	115 Lumens / Watt	90MM DIA	75x75x75
PLATO RD 12	12W	1920 / 1860 / 1800	115 Lumens / Watt	90MM DIA	75x75x75
PLATO RD 15	15W	2400 / 2325 / 2250	115 Lumens / Watt	110 MM DIA	90x95
PLATO RD 20	20W	3200 / 3100 / 3000	115 Lumens / Watt	110 MM DIA	90x95

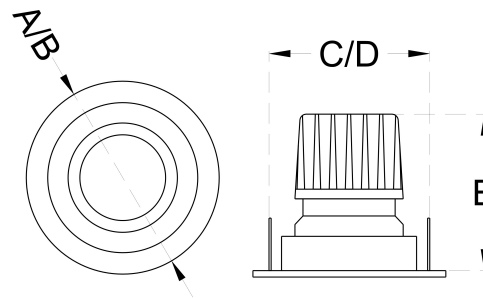



Application: Residential, Office buildings, Retail, Sports facilities, Studio, Stage, Supermarkets, Library

Code	Watt	Lumen CW/NW/WW	Efficacy	A x B	C x D x E
VALUE 3	03W	480 / 465 / 450	115 Lumens / Watt	38 MM DIA	28x28
VALUE 7	07W	1120 / 1085 / 1050	115 Lumens / Watt	68 MM DIA	59x65
VALUE 12	12W	1920 / 1860 / 1800	115 Lumens / Watt	83 MM DIA	75X75
VALUE 18	18W	2880 / 2790 / 2700	115 Lumens / Watt	95 MM DIA	85X90

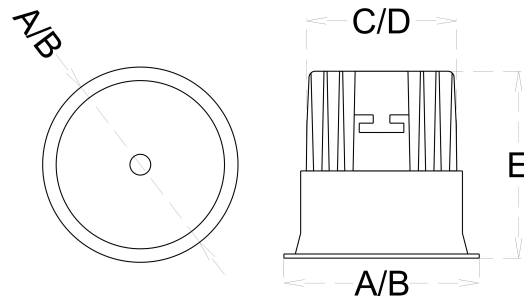



Application: Residential, Office buildings, Retail, Sports facilities, Studio, Stage, Supermarkets, Library

Code	Watt	Lumen CW/NW/WW	Efficacy	A x B	C x D x E
DUSK 7	7W	1120 / 1085 / 1050	115 Lumens / Watt	65 MM DIA	55X70
DUSK 12	12W	1920 / 1860 / 1800	115 Lumens / Watt	85 MM DIA	75X85
DUSK 18	18W	2880 / 2790 / 2700	115 Lumens / Watt	85 MM DIA	75X100
DUSK 24	24W	3840 / 3720 / 3600	115 Lumens / Watt	110MM DIA	95X90

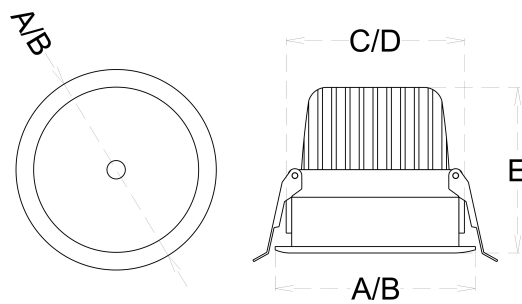



Application: Residential, Office buildings, Retail, Sports facilities, Studio, Stage, Supermarkets, Library

Code	Watt	Lumen CW/NW/WW	Efficacy	A x B	C x D x E
RAY 7	7W	1120 / 1085 / 1050	115 Lumens / Watt	40 MM DIA	35X55
RAY 12	12W	1920 / 1860 / 1800	115 Lumens / Watt	60 MM DIA	55X80
RAY 18	18W	2880 / 2790 / 2700	115 Lumens / Watt	75 MM DIA	65X98

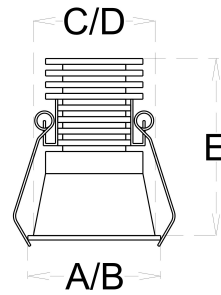
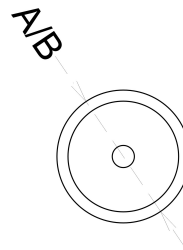



Application: Residential, Office buildings, Retail, Sports facilities, Studio, Stage, Supermarkets, Library

Code	Watt	Lumen CW/NW/WW	Efficacy	A x B	C x D x E
IYON SPOT 20	20W	3200 / 3100 / 3000	115 Lumens / Watt	231x47x46	217x33x46

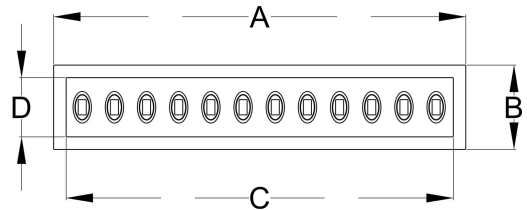
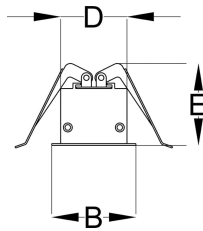



Application: Residential, Office buildings, Retail, Sports facilities, Studio, Stage, Supermarkets, Library

Code	Watt	Lumen CW/NW/WW	Efficacy	A x B	C x D x E
LASER SPOT 10	10W	1600 / 1550 / 1500	115 Lumens / Watt	147x47x36	137x37x35
LASER SPOT 20	20W	3200 / 3100 / 3000	115 Lumens / Watt	280x47x36	270x37x35
LASER SPOT 30	30W	4800 / 4650 / 4500	115 Lumens / Watt	413x47x36	403x37x35

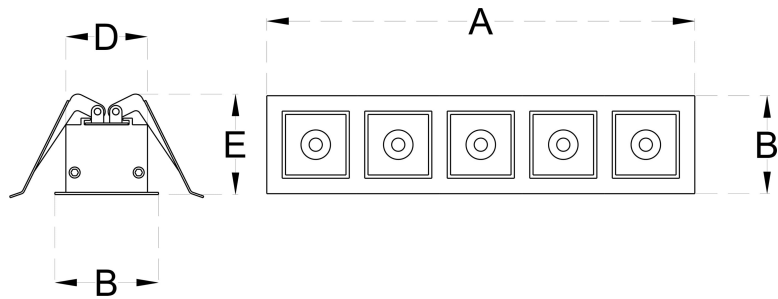



Application: Residential, Office buildings, Retail, Sports facilities, Studio, Stage, Supermarkets, Library

Code	Watt	Lumen CW/NW/WW	Efficacy	A x B	C x D x E
STAR 20	20W	3200 / 3100 / 3000	135 Lumens / Watt	401x153x95	-

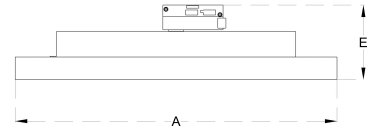
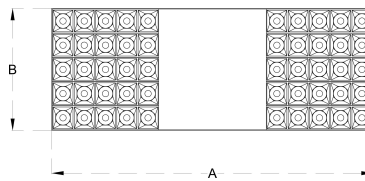



Application: Residential, Office buildings, Retail, Sports facilities, Studio, Stage, Supermarkets, Library

Code	Watt	Lumen CW/NW/WW	Efficacy	A x B	C x D x E
HIPPO 30	30W	4800 / 4650 / 4500	115 Lumens / Watt	160	140x115
HIPPO 40	40W	6400 / 6200 / 6000	115 Lumens / Watt	160	140x130

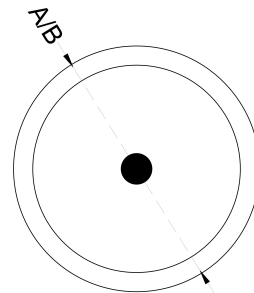
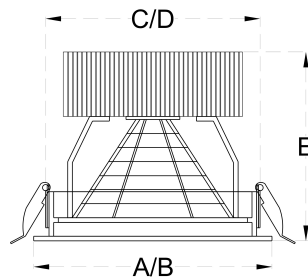



Application: Residential, Office buildings, Retail, Sports facilities, Studio, Stage, Supermarkets, Library

Code	Watt	Lumen CW/NW/WW	Efficacy	A x B	C x D x E
MAX 30	30W	4800 / 4650 / 4500	115 Lumens / Watt	185x185x120	163x163
MAX 40	40W	6400 / 6200 / 6000	115 Lumens / Watt	185x185x120	163x163

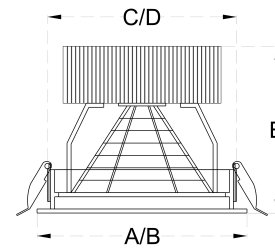
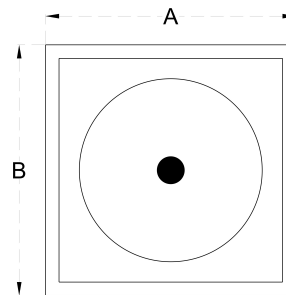



Application: Residential, Office buildings, Retail, Sports facilities, Studio, Stage, Supermarkets, Library

Code	Watt	Lumen CW/NW/WW	Efficacy	A x B	C x D x E
MAX 60	60W (2x30W)	9600 / 9300 / 9000	115 Lumens / Watt	345x185x120	323x163
MAX 80	80W (2x40W)	12800 / 12400 / 12000	115 Lumens / Watt	345x185x120	323x163

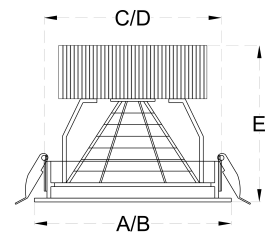
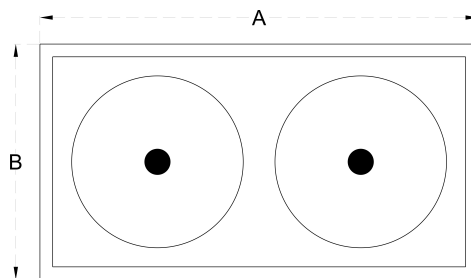



Application: Residential, Office buildings, Retail, Sports facilities, Studio, Stage, Supermarkets, Library

Code	Watt	Lumen CW/NW/WW	Efficacy	A x B	C x D x E
MAX 90	90W (3x30W)	14400 / 13950 / 13500	115 Lumens / Watt	530x185x120	483x163
MAX 120	120W (3x40W)	1920 / 1860 / 1800	115 Lumens / Watt	530x185x120	483x163

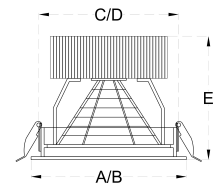
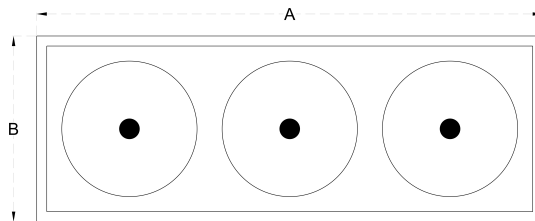



Application: Residential, Office buildings, Retail, Sports facilities, Studio, Stage, Supermarkets, Library

Code	Watt	Lumen CW/NW/WW	Efficacy	A x B	C x D x E
ZOOM 24	24W	3840 / 3720 / 3600	115 Lumens / Watt	120 Dia	110 Dia x 115
ZOOM 36	36W	5760 / 5580 / 5400	115 Lumens / Watt	145 Dia	135 Dia x 115

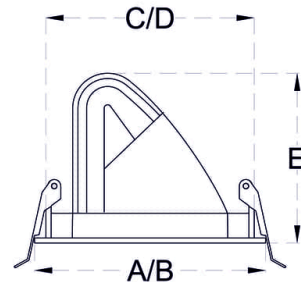
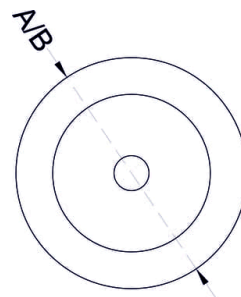



Application: Residential, Office buildings, Retail, Sports facilities, Studio, Stage, Supermarkets, Library

Code	Watt	Lumen CW/NW/WW	Efficacy	A x B	C x D x E
TURBO SURFACE 60 12	12W	1920 / 1860 / 1800	115 Lumens / Watt	63 Dia x 140	-
TURBO SURFACE 85 15	15W	2400 / 2325 / 2250	115 Lumens / Watt	85 Dia x 140	-
TURBO SURFACE 85 20	20W	3200 / 3100 / 3000	115 Lumens / Watt	85 Dia x 140	-
TURBO SURFACE 100 25	25W	4000 / 3875 / 3750	115 Lumens / Watt	100 Dia x 190	-
TURBO SURFACE 85 30	30W	4800 / 4650 / 4500	115 Lumens / Watt	85 Dia x 195	-

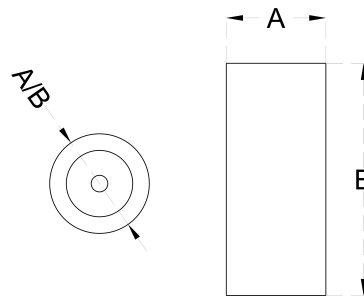

TURBO SUSPENDED



Application: Residential, Office buildings, Retail, Sports facilities, Studio, Stage, Supermarkets, Library

Code	Watt	Lumen CW/NW/WW	Efficacy	A x B	C x D x E
TURBO SUSPENDED 60 12	12W	1920 / 1860 / 1800	115 Lumens / Watt	63 Dia x 140	-
TURBO SUSPENDED 85 15	15W	2400 / 2325 / 2250	115 Lumens / Watt	85 Dia x 140	-
TURBO SUSPENDED 85 20	20W	3200 / 3100 / 3000	115 Lumens / Watt	85 Dia x 140	-
TURBO SUSPENDED 100 25	25W	4000 / 3875 / 3750	115 Lumens / Watt	100 Dia x 190	-
TURBO SUSPENDED 85 30	30W	4800 / 4650 / 4500	115 Lumens / Watt	85 Dia x 140	-

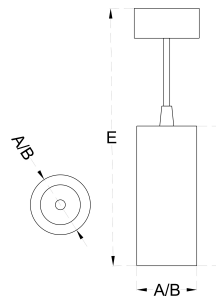



Application: Residential, Office buildings, Retail, Sports facilities, Studio, Stage, Supermarkets, Library

Code	Watt	Lumen CW/NW/WW	Efficacy	A x B	C x D x E
TURBO TRACK 60 12	12W	1920 / 1860 / 1800	115 Lumens / Watt	63 Dia x 140	-
TURBO TRACK 85 15	15W	2400 / 2325 / 2250	115 Lumens / Watt	85 Dia x 140	-
TURBO TRACK 85 20	20W	3200 / 3100 / 3000	115 Lumens / Watt	85 Dia x 140	-
TURBO TRACK 100 25	25W	4000 / 3875 / 3750	115 Lumens / Watt	100 Dia x 190	-
TURBO TRACK 85 30	30W	4800 / 4650 / 4500	115 Lumens / Watt	85 Dia x 140	-

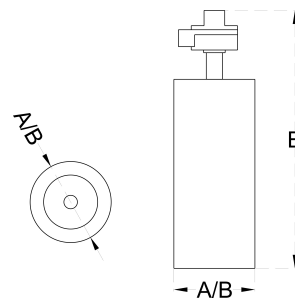

TURBO TRACK SURFACE



Application: Residential, Office buildings, Retail, Sports facilities, Studio, Stage, Supermarkets, Library

Code	Watt	Lumen CW/NW/WW	Efficacy	A x B	C x D x E
TURBO TRACK SURFACE 60 12	12W	1920 / 1860 / 1800	115 Lumens / Watt	63 Dia x 140	-
TURBO TRACK SURFACE 85 15	15W	2400 / 2325 / 2250	115 Lumens / Watt	85 Dia x 140	-
TURBO TRACK SURFACE 85 20	20W	3200 / 3100 / 3000	115 Lumens / Watt	85 Dia x 140	-
TURBO TRACK SURFACE 85 30	30W	4800 / 4650 / 4500	115 Lumens / Watt	85 Dia x 140	-

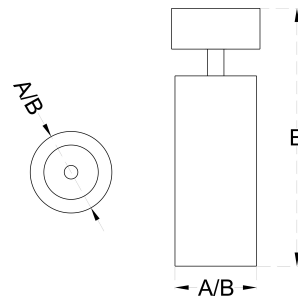



Application: Office buildings, Retail, Supermarkets, Hospitality, Library

Code	Watt	Lumen CW/NW/WW	Efficacy	A x B	C x D x E
AQUA SURFACE 5	05W	800 / 775 / 750	115 Lumens / Watt	50 Dia x 105	-
AQUA SURFACE 15	15W	2400 / 2325 / 2250	115 Lumens / Watt	80 Dia x 150	-
AQUA SURFACE 25	25W	4000 / 3875 / 3750	115 Lumens / Watt	120 Dia x 150	-

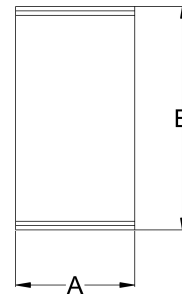
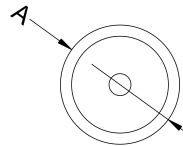



Application: Office buildings, Retail, Supermarkets, Hospitality, Library

Code	Watt	Lumen CW/NW/WW	Efficacy	A x B	C x D x E
AQUA UP DOWN 24	24W	3840 / 3720 / 3600	115 Lumens / Watt	80 Dia x 195	-

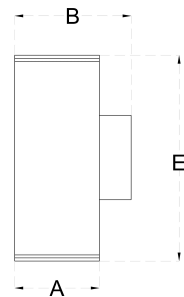
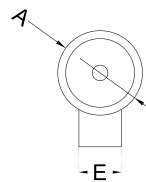



Application: Office buildings, Retail, Supermarkets, Hospitality, Library

Code	Watt	Lumen CW/NW/WW	Efficacy	A x B	C x D x E
AQUA DOWN 15	15W	2400 / 2325 / 2250	115 Lumens / Watt	80 Dia x 150	-

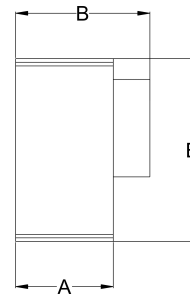
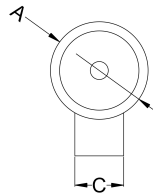



Application: Residential, Office buildings, Retail, Sports facilities, Studio, Stage, Supermarkets, Library

Code	Watt	Lumen CW/NW/WW	Efficacy	A x B	C x D x E
STONE 30	30W	4800 / 4650 / 4500	115 Lumens / Watt	Dia 140 x 100	Dia 130 x 100
STONE 40	40W	6400 / 6200 / 6000	115 Lumens / Watt	Dia 140 x 100	Dia 130 x 100

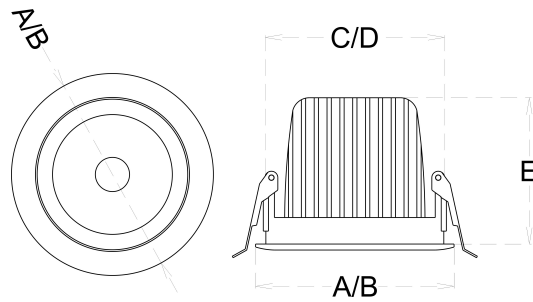



Application: Residential, Office buildings, Retail, Sports facilities, Studio, Stage, Supermarkets, Library

Code	Watt	Lumen CW/NW/WW	Efficacy	A x B	C x D x E
BULLET 25	25W	4000 / 3875 / 3750	115 Lumens / Watt	105x105x90	90x90x90
BULLET 35	35W	5600 / 5425 / 5250	115 Lumens / Watt	118x118x102	102x102x102

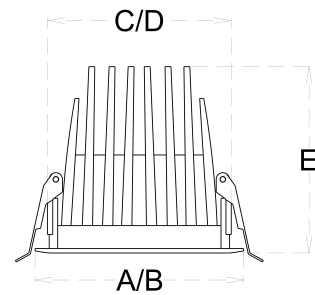
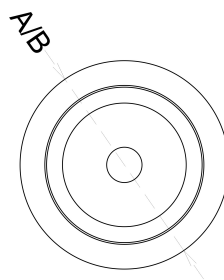



Application: Residential, Office buildings, Retail, Sports facilities, Studio, Stage, Supermarkets, Library

Code	Watt	Lumen CW/NW/WW	Efficacy	A x B	C x D x E
BULLET TRACK 25	25W	4000 / 3875 / 3750	115 Lumens / Watt	75x100	-
BULLET TRACK 35	35W	5600 / 5425 / 5250	115 Lumens / Watt	90x115	-

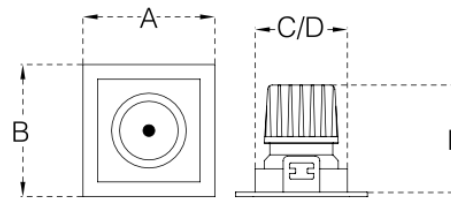



Application: Residential, Office buildings, Retail, Sports facilities, Studio, Stage, Supermarkets, Library

Code	Watt	Lumen CW/NW/WW	Efficacy	A x B	C x D x E
TRENDY 20	20W	3200 / 3100 / 3000	115 Lumens / Watt	140x130	-

